

SPM-400 Irisspjäll med bulb

Artikelnummer: [6256](#)

Variant : Standardvärde



Beskrivning

Function

The SPM is an iris damper for measurement and adjustment of the air flow with enhanced choking ability. The SPM has the following specifications: low sound level, centrally formed air flow and fixed test points for precise measurements.

This device can be used for supply as well as for extract air.

Design

The damper is manufactured from galvanised sheet steel and is fitted with a rubber gasket tested for air-tightness in class C according to EN 1751. It has an adjustment aperture which in combination with centrally situated sealing rubber ball can close the entire cross-section. As accessory the access door...

[Hitta mer information i vår webbkatalog](#)

Tekniska parametrar

Dimensioner och vikt

Vikt	7,3 kg
------	--------

Dimensioner

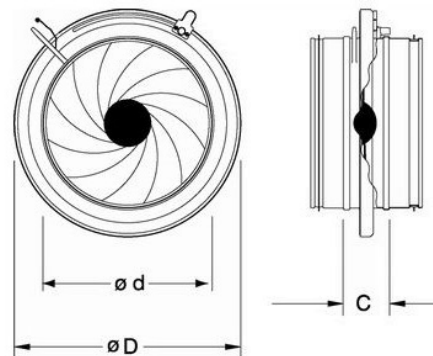

Dimensions	Value mm
$\varnothing d$	399
C	70
$\varnothing D$	560
Part	Weight kg
SPM-400 Iris damper with bulb	7.30

