

LPKB 315 D1

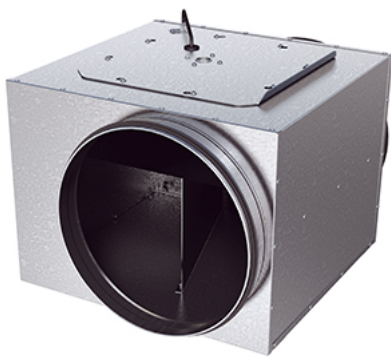

- Low profile duct fan with circular connections.
- A small and useful duct fan which are perfect for spaces with minimum height clearance.
- With one connection on the inlet side.
- High capacity and efficiency with low sound levels.
- Operational in both 50 and 60 Hz.
- Impeller with backward curved blades.
- The external rotor motor has maintenance-free sealed ball-bearings.
- Integrated motor protection.
- Junction box has enclosure class IP 54.
- For speed control a transformer or electronic speed controller can be connected.
- Fan housing is manufactured from galvanized sheet steel.
- Duct connections are equipped with rubber seals.
- The fan is intended to be installed in a duct system.
- A duct connected fan can be installed outside or in damp environments.
- The mounting brackets simplify installation in any position.

DIAGRAMS

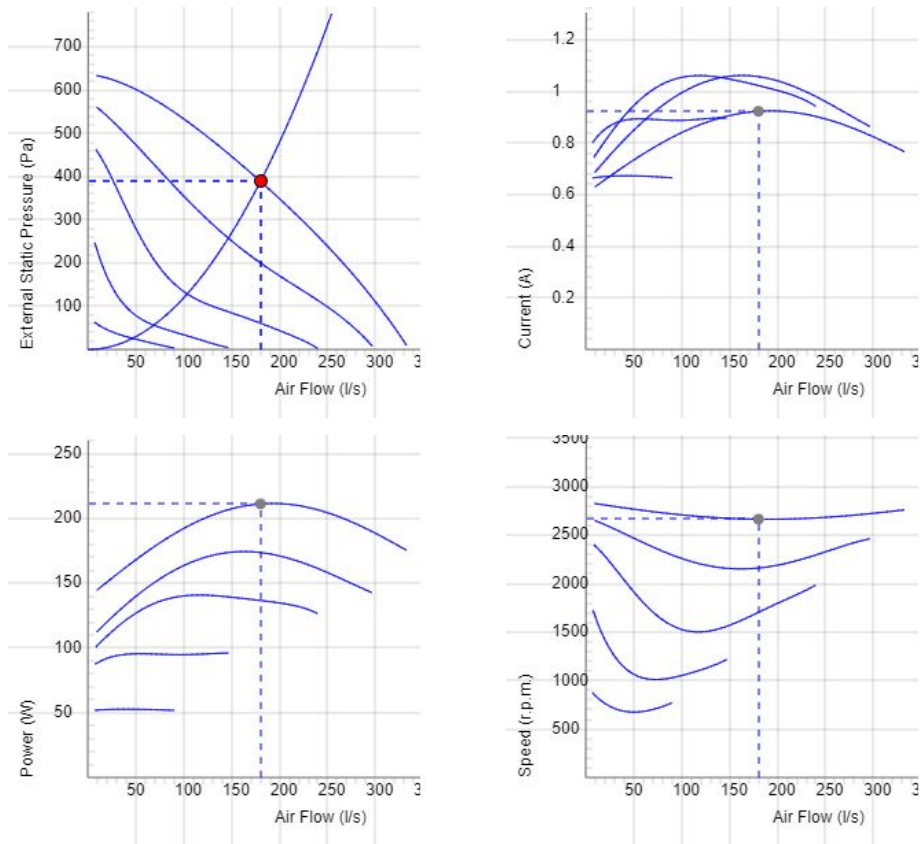

Data

Air Flow (l/s) 180	External static pressure (Pa) 389	Power (W) 211	Speed (r.p.m.) 2665	Current (A) 0.923	Voltage (V) 230
-----------------------	--------------------------------------	------------------	------------------------	----------------------	--------------------

DIAGRAMS

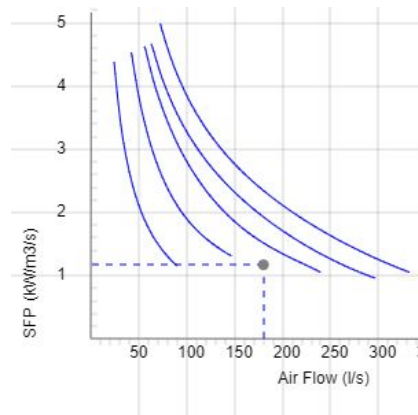
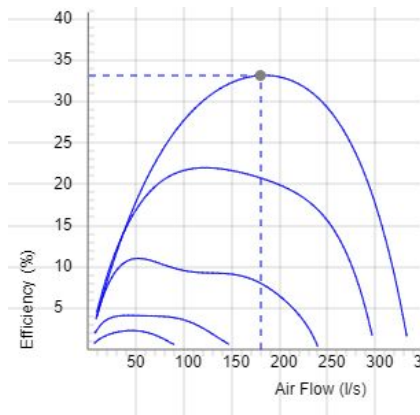

DATA

Efficiency (%)	33.2
SFP (kW/m ³ /s)	1.17

SOUND DATA

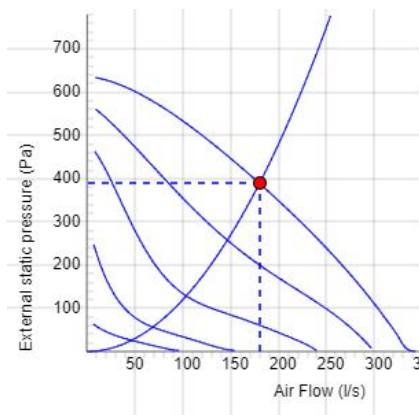

	Tot	63	125	250	500	1k	2k	4k	8k
Inlet Lw dB(A)	73	58	61	69	64	63	64	62	60
Outlet Lw dB(A)	77	60	62	73	70	66	69	65	58
Surrounding Lw dB(A)	60	36	43	57	54	49	48	45	42
Surrounding Lp dB (A) 20m ² Sabine, hemispherical 3m	53								

Data - SOUND

Air Flow (l/s)	External static pressure (Pa)	Power (W)	Speed (r.p.m.)	Current (A)	Efficiency (%)	SFP (kW/m ³ /s)	Voltage (V)
180	389	211	2665	0.923	33.2	1.17	230

TECHNICAL DATA

LPKB 315 D1 7540701

Parameter	Value	Unit
Voltage	230	V
Phase	1	~
Frequency	50	Hz
Optional frequency	60	Hz
Power	212	W
Current	0.93	A
Current when speed controlled	1.06	A
Speed	2670	r.p.m.
Max. temperature of transported air	80	°C
Sound pressure level at 3 m	53	dB(A)
Weight	13.4	kg
Enclosure class	44	IP
Insulation class, motor	F	
Capacitor	6	µF
Duct connection	315	mm
Max. flow	335	l/s
Max. pressure	638	Pa
Voltage range	220-240	V

PRODUCT INFORMATION SHEET

Parameter	Value	Unit
(a) Manufacturer	Östberg	-
(b) Model code	LPKB 315 D1	-
(c) Declared type	NRVU / UVU	-
(d) Type of drive	Multi-speed drive (accessory)	-
(e) Type of HRS	none	-
(f) Thermal efficiency	N/A	%
(g) Nominal flow rate	0.193	m ³ /s
(h) Effective power input	0.212	kW
(i) SFP int	N/A	W/(m ³ /s)
(j) Face velocity	2.5	m/s
(k) Nominal external pressure	364	Pa
(l) Internal pressure drop	N/A	Pa
(n) Static efficiency	44.5	%
(o) External (and internal) leakage rate	0.16 (N/A)	%
(p) Filter classification	N/A	%
(q) Visual filter warning	N/A	-
(r) Sound power level	60	dB LwA
(s) Disassembly instructions	www.ostberg.com	-

WIRING DIAGRAM

4040001

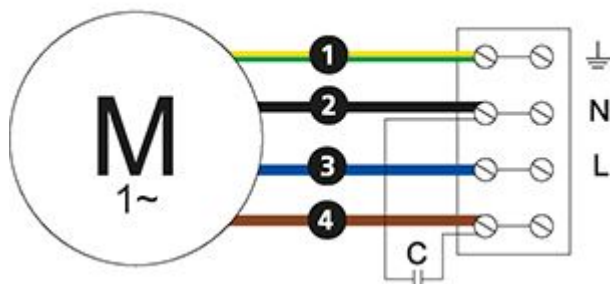

Ⓜ = Fan Motor

Ⓜ1 = Fan Motor

Ⓜ2 = Fan Motor

Ⓜ3 = Rotor Motor

① = Yellow/Green

② = Black

③ = Blue

④ = Brown

⑤ = White

⑥ = Orange

⑦ = Grey

⑧ = Red

⑨ = Green

⑩ = Violet

⑪ = Quick switch

⑫ = Yellow

DIMENSIONS

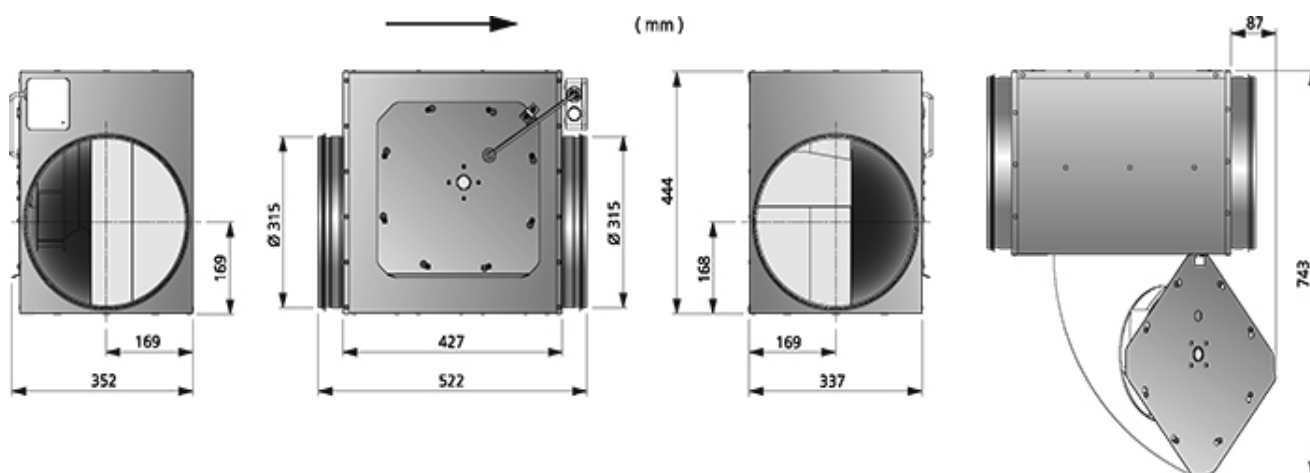

ACCESSORIES

Mechanical accessories



Mounting clamp MK 315



Safety grille BSV 315



Back draught shutter RSK 315



Louvre YG 315



Louvre shutter VK 315



Filterbox FLK 315



Filterbox FLF 315



Silencer LDC 315

Electrical accessories



Transformer controller VRTE 1



Transformer controller VRDE 1.5



Speed controller VRS 2.0