

 Heat Recovery Units • Made in Sweden

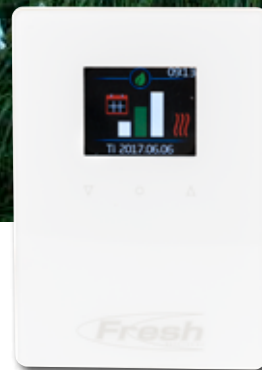

FRESH FRX

TECHNOLOGY AND FUNCTION IN HARMONY



FRESH FRX



Fresh FRX is Swedish-made high-quality heat recovery units designed and manufactured in Sweden. Thanks to this it fulfills the requirements on quality, service friendly, ease of maintenance and maximum energy savings / energy class. Obviously it meets Ecodesign demands of 2018.

Choose between vertical or horizontal connections of the ducts. Depending on how the air is connected it can be ordered in left or right version.

The units are available in four sizes: 180 – 1980 m³/h

FRESH FRX is manufactured in galvanized steel and externally powder coated in white (RAL9003).

FRESH FRX is insulated with 50 mm mineral wool and units can be placed in a cold space.

FRESH FRX is delivered with ePM1 60% (F7) filter on supply air and ePM10 60% (M5) filters on exhaust air.



FRX 110 S/T

- Control: Fresh
- Heat recovery: Rotor
- After heater: Electrical (built-in) or water (external)
- Fans: Plug fans with EC-motors
- Accessories: Dampers, coils etc.

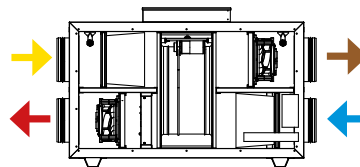
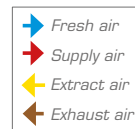
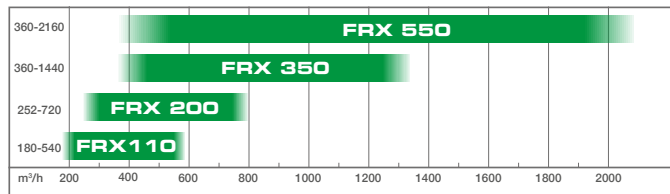
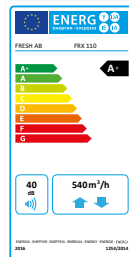

FRX 110S is reversible either right/left configuration.

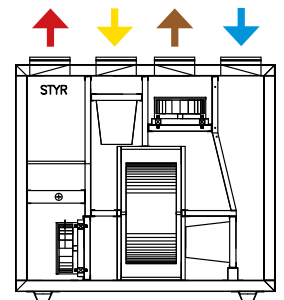

FRX 110T is delivered in either right or left configuration. Here shown as left configuration.

FRX 200 S/T

- Control: Fresh
- Heat recovery: Rotor
- After heater: Electrical (built-in) or water (external)
- Fans: Plug fans with EC-motors
- Accessories: Dampers, coils etc.

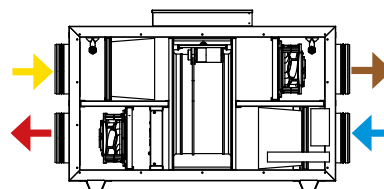
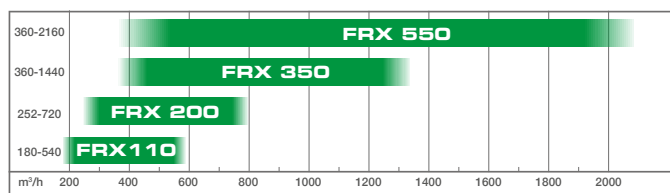
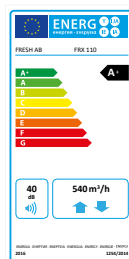

FRX 200S is reversible either right/left configuration.

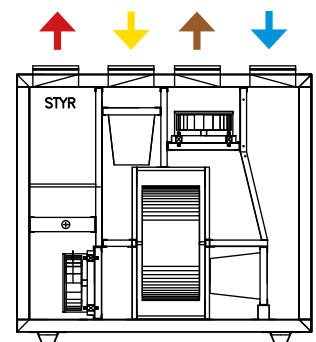

FRX 200T is delivered in either right or left configuration. Here shown as left configuration.

Horizontal (S)

Model	Measure (mm)				Weight (kg)	Efficiency %	Max capacity m ³ /h@150 Pa	Energy class ErP 2018
	L	W	H	Ø				
FRX 110 S	1076	564	730	200	89	82	540	A+
FRX 200 S	1176	704	801	250	115	84	720	A+
FRX 350 S	1450	800	1162	315	285	81	1260	A+
FRX 550 S	1650	900	1268	400	355	80	1980	A+

Vertical (T)

Model	Measure (mm)				Weight (kg)	Efficiency %	Max capacity m ³ /h@150 Pa	Energy class ErP 2018
	L	W	H	Ø				
FRX 110 T	1031	560	943	160	100	82	540	A+
FRX 200 T	1177	702	1113	200	136	84	720	A+
FRX 350 T	1400	800	1400	250	285	81	1260	A+
FRX 550 T	1680	900	1500	315	355	80	1980	A+

FRX 350 S/T

Control: Fresh
 Heat recovery: Rotor
 After heater: Electrical (built-in) or water (built-in)
 Fans: Plug fans with EC-motors
 Accessories: Dampers, coils etc.

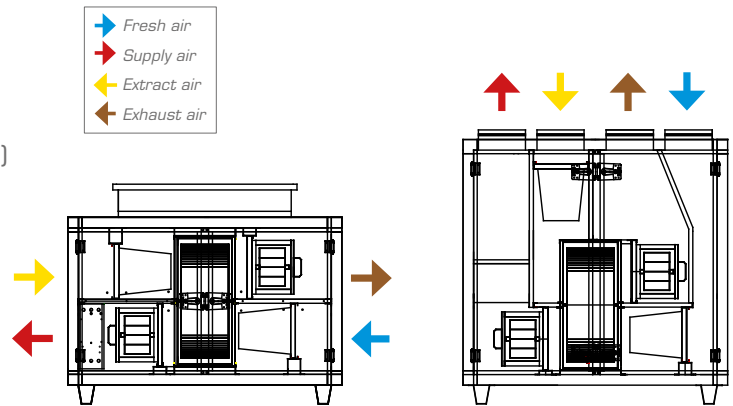
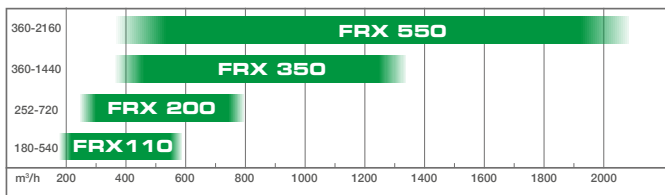

FRX 350S/T is delivered in either right or left configuration. Here shown as left configuration

FRX 550 S/T

Control: Fresh
 Heat recovery: Rotor
 After heater: Electrical (built-in) or water (built-in)
 Fans: Plug fans with EC-motors
 Accessories: Dampers, coils etc.

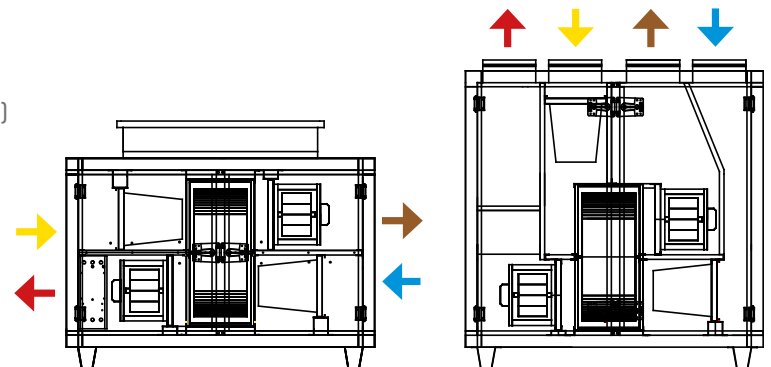
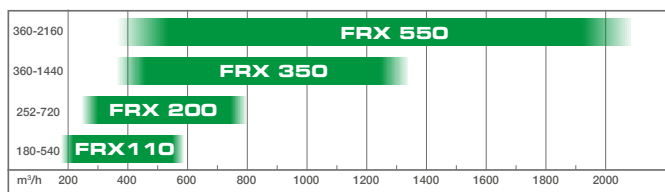

FRX 550S/T is delivered in either right or left configuration. Here shown as left configuration



Dimensioning

For detailed data use our air handling unit selection software Fresh Designer. Download free of charge at website: www.fresh.se It presents all the data and dimensions as well as a detailed energy calculations with LCC Calculation. Drawings in 3D can also be created.

Control Equipment

The integrated control equipment is prepared for most common control modes and has an user-friendly interface. The following functions are included from start:

- Weekly timer
- Temperature control, supply- or exhaust temperature or by room sensor
- Demand control via CO₂, pressure or humidity
- Outdoor compensation of airflow
- Overriding the control panel via external signal
- Night cooling (free cooling at night)
- Fire protection features
- Communication via Modbus
- Showing values of sensors on the panel
- Filters and rotor guard



FRESH AB
Gränsholmsvägen 136 **Tel** +46 470 70 77 00 **E-mail** info@fresh.se
SE-355 99 GEMLA **Fax** +46 470 70 77 39 **Web** www.fresh.eu

FRX SERIEN Export EN Edition 2019-2 • Art no 008958
Copyright © Fresh AB 2017. All rights reserved.
Fresh® and the Fresh® logotype are trademarks or registered trademarks of Fresh AB in Sweden and/or other countries.

